



ZIP 52 Finishing | Perfect Flow

DOUBLE DIAPHRAGM PUMPS FOR WAGNER AIRSPRAY APPLICATION



- Excellent finishing quality
- High reliability
- Versatile and economic

WAGNER AirSpray - Perfect finishing for high quality surfaces

WAGNER AirSpray technology

In the WAGNER AirSpray process, the paint is atomized entirely by air. The task of the pump is to feed the gun with a constant flow of materials.

ZIP pumps are perfect for WAGNER AirSpray applications. Whether you are using thick high viscosity material, shear sensitive or thixotropic, heat critical paints or just ordinary coatings, ZIP finishing equipment meets all the expectations of a professional painter.



ZIP 52 technology

Two coupled diaphragms (2) are moving from the left to the right and back by help of pressurized air (3). The steering valve (4) guides the air to the side where the diaphragm is moved to contract the fluid chamber (1). Material is being transported by contraction and expansion of the fluid chamber volume and the inlet- and outlet valves (5&6).

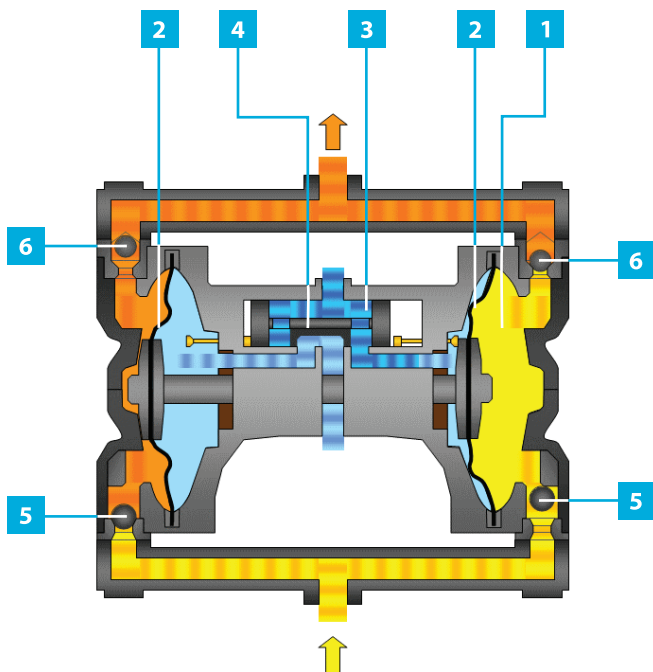

- 1 Pumped material / material chamber
- 2 Long life diaphragm
- 3 Pressurized air
- 4 Steering valve
- 5 Material inlet valve
- 6 Material outlet valve

Great advantages for your business

ZIP 52 finishing & ZIP 52 Eco Perfect Flow: Designed for your needs!



Wood Finishing



Metal Finishing



Plastic, Leather and Textile Finishing



TYPICAL APPLICATIONS

If you have to stop to refill your cup gun or pressure pot often, then it is time to think about a professional feeding system. ZIP 52 Finishing and ZIP 52 Eco Perfect Flow are perfect solutions for continuous feed of manual and automatic applications in the following markets:

- Wood and furniture industry
- General metal industry
- Plastic finishing
- Leather and textile application
- Glass coating

TYPICAL FLUIDS

- Stains, primers and fillers
- Base- and clearcoats
- Solvent- and waterbased paints
- 2-K materials
- High solid materials
- UV-paints
- Metallic paints
- Special effect paints
- Glues, adhesives

High quality surfaces!

ZIP 52 Finishing

ZIP 52 Finishing meets the highest expectations in surface coating quality. The Fine Flow Controller (FFC) with the integrated material filter, guarantees the smoothest material transportation.

1 High-performance double diaphragm pump

The extremely reliable, durable, yet compact design of the pump makes it suitable for manual or automatic as well as multiple gun applications. Special long life diaphragms enable the pump to run at high speeds and attain high performance standards for long periods of time without damage.

WAGNER
AirSpray

2 Easy and comfortable

All control and adjustment elements are positioned on the front control panel for comfortable operation.

3 No pulsation

Pump pulsations are reduced close to zero with the innovative Fine Flow Controller. The FFC regulates the material pressure precisely and constantly. This allows the paint to circulate in the container while spraying to prevent sedimentation.

4 Modular

The basic unit can be completed with a variety of mounting options: stand, trolley or wall mounting bracket.



ZIP Eco Perfect Flow

For materials like heavy primers, glues and thick materials, ZIP Eco Perfect Flow works without the fluid regulator yet still with minimum pulsations. FFC available as an option.





Precise flow rates without pulsation

Fine Flow Controller

The WAGNER Fine Flow Controller (FFC) 3-in-1 is a patented fluid regulator with an integrated material filter. The excellent regulating characteristic combined with the anti-pulsation effect of the filter chamber, guarantees a very precise and almost pulsation free material flow. The absence of any dead spaces enables quick color change and low consumption of flushing fluids and less waste material.



The FFC maintains a regular and pulsation-free flow, ideal for maximum finishing quality and precise application.

- Less internal dead space means easier, faster and cheaper cleaning and color changes.
- Multi-gun applications such as automatic sprayers, carousels, reciprocators and robots can be used with the FFC.



THE UNIT COMES COMPLETE WITH:

- 1 Large material filter**
Filters out any debris, which helps the longevity of the pump. The large filter extends the time needed between changes, thus reducing down-time.
- 2 Air regulators**
Pump is equipped with air-regulators and atomizing air-regulator.
- 3 Flexible suction hose & 4-legs stand**

ZIP 52 Finishing / ZIP 52 Eco Perfect Flow - A modular system

A modular system for maximum flexibility

The WAGNER ZIP 52 Finishing and the ZIP 52 Eco Perfect Flow is a complete modular system. A wide range of mounting equipment, WAGNER AirSpray guns, hose packages, fine flow controllers, fluid regulators and special material filters, make these units perfect for almost all kinds of application needs.

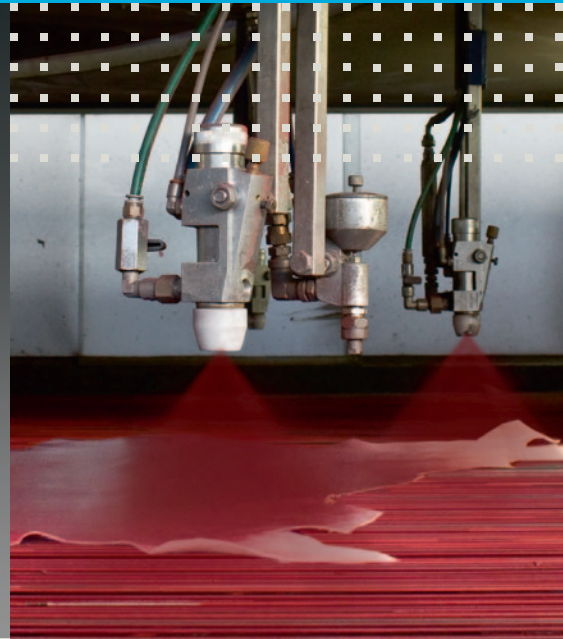

1 Mounting equipment

A variety of mounting equipment is available for ZIP 52 Finishing including stand, trolley, wall mounting or drum covers.

2 Guns

There is a wide range of manual and automatic WAGNER AirSpray guns for all your application needs. The guns are available in conventional AirSpray, medium pressure, HVLP and HVLP plus.

3 Hose packages

Material hoses and air hoses are available separately as well as complete hose packages pre-configured in different lengths.

4 Fine Flow Controllers & Anti-Pulsation Tanks

A wide range of fluid regulators, Fine Flow Controllers and anti-pulsation tanks are available (see our accessory catalog).

5 Material filters

Specially designed material filters are available for premium filter performance and easy, fast changing.

6 Hopper kit

A special 5l hopper kit is available. Ideal for customers handling many color changes and small quantities.

The right finishing system for your purpose

Select your finishing unit

ZIP 52 Finishing

For premium surface quality this unit is completely equipped with air regulator, Fine Flow Controller and atomizing air regulator.

ZIP 52 Eco Perfect Flow

The finishing unit is used for WAGNER AirSpray applications. Equipped with air regulators, atomizing air regulator, large filter and the anti-pulsation tank instead of FFC.



Technical Data

Fine Flow Controller

Technical Data	FFC
Wetted parts (standard version)	consital, stainless steel, PTFE, PP
Wetted parts (stainless steel version)	stainless steel, PTFE, PP
Max. material inlet pressure	14 bar, 203 psi
Regulated pressure	0.5 - 8 bar, 7 - 116 psi
Material connection	2 x G 1/4"-F BSP
Air connection	G 1/8"-F BSP

Technical Data

ZIP 52 Finishing / Eco PF

Technical Data	ZIP 52 Finishing	ZIP 52 Eco PF
Pressure ratio	1:1	1:1
Max. material pressure	8 bar, 116 PSI	8 bar, 116 PSI
Max. air pressure	8 bar, 116 PSI	8 bar, 116 PSI
Air connection	G 1/4"	G 1/4"
Material connection	G 1/2"	G 1/2"
Wetted parts	Stainless steel / Aluminum / PTFE/PPS	
Volumetric flow (per double stroke)	108 cm ³ , 6.59 in ³	65 cm ³ , 3.97 in ³



WAGNER AirSpray guns

WAGNER offers a wide range of manual and automatic AirSpray guns, as well as guns for electrostatic applications. Most of these guns are available for conventional AirSpray, medium pressure, HVLV and HVLV plus. A variety of nozzles and AirCaps enables the application of almost any kind of materials.

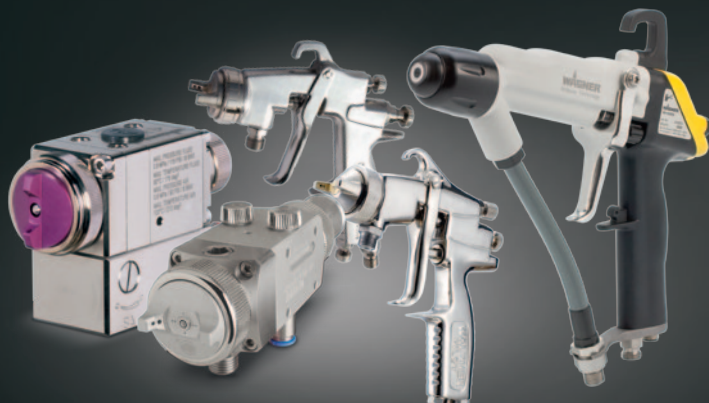

Low pressure diaphragm pumps

More WAGNER ZIP

The ZIP pneumatic double diaphragm pumps were designed specifically for a reduction in air consumption coupled with better performance and maximum reliability. The exclusive design and the broad application spectrum enable its use for corrosive, abrasive and highly viscous liquid media. ZIP pumps also support the feeding of paint supply systems; feeding and circulation of printing ink, solvents, paints, chemicals and oils; the disposal of liquid waste; the supply of low-viscosity adhesives; and filling/emptying of tanks, drums and containers.

2-K Capability





The WAGNER TwinControl is a unique system that can handle 2-K materials. The mobile unit is precise, compact and easy to handle. The automatic flushing process make the unit economical. The low pressure TwinControl is perfect for many different materials with WAGNER AirSpray applications. It has a mixing ratio from 0.1:1 up to 20:1 and a flow rate up to 3.6 l/min.







www.wagner-group.com



BASIC UNITS / SPRAYPACKS

	ZIP 52 Finishing			ZIP 52 ECO Perfect Flow	
Basic units / Spraypacks					
					
Description	DDP ZIP 52 Alu Finish Basic	DDP ZIP 52 Inox Finish Basic	DDP ZIP 52 Alu Finish SP5 Spraypack	ZIP 52 ECO Perfect Flow - SP 5 Spraypack	ZIP 52 ECO Perfect Flow
Stand	<input type="checkbox"/>	<input type="checkbox"/>	<input type="checkbox"/>	<input checked="" type="checkbox"/>	<input checked="" type="checkbox"/>
Pump body	Aluminum	Stainless Steel	Aluminum	Aluminum	Aluminum
Air regulator	<input checked="" type="checkbox"/>	<input checked="" type="checkbox"/>	<input checked="" type="checkbox"/>	<input checked="" type="checkbox"/>	<input type="checkbox"/>
Fine Flow Controller	<input checked="" type="checkbox"/>	<input checked="" type="checkbox"/>	<input checked="" type="checkbox"/>	<input type="checkbox"/>	<input type="checkbox"/>
Material filter	<input checked="" type="checkbox"/>	<input checked="" type="checkbox"/>	<input checked="" type="checkbox"/>	<input checked="" type="checkbox"/>	<input checked="" type="checkbox"/>
Suction hose	<input checked="" type="checkbox"/>	<input checked="" type="checkbox"/>	<input checked="" type="checkbox"/>	<input checked="" type="checkbox"/>	<input checked="" type="checkbox"/>
Material hose	<input type="checkbox"/>	<input type="checkbox"/>	<input checked="" type="checkbox"/>	<input checked="" type="checkbox"/>	<input type="checkbox"/>
Gun	<input type="checkbox"/>	<input type="checkbox"/>	SP 5	SP 5	<input type="checkbox"/>
Item No.	U760.00	U765.00	U760.00S/5	U731.PACK/SP5	U731.00

ACCESSORIES

Description	ZIP Finishing	ZIP Eco Perfect Flow	
Guns			
	WAGNER AirSpray gun SP5 0.8 mm	R950.08	R950.08
	WAGNER AirSpray gun SP5 1.0 mm	R950.10	R950.10
	WAGNER AirSpray gun SP5 1.2 mm	R950.12	R950.12
	WAGNER AirSpray gun SP5 1.5 mm	R950.15	R950.15
	WAGNER AirSpray gun SP5 1.8 mm	R950.18	R950.18
Hoses			
	Double hose LP D6x8 mt7,5 1/4"	S419.00G	S419.00G
	Double hose LP D6x8 mt7,5 1/4", SSt-fittings	S419.00GI	S419.00GI
Suction systems			
	Flexible suction hose, inside Ø 16mm, connection thread: G 1/2" – M ①	T4016.00Z	T4016.00Z
	Flexible suction hose - stainless steel, inside Ø 16mm, connection thread: G 1/2" – M ①	T4016.00ZI	T4016.00ZI
	Hopper 5l set ZIP (incl. elbow) ②	2315385	2315385
Mounting			
	Wall bracket ①	T760.00M	T760.00M
	Stand ②	T760.00S	T760.00S
	Wheel / Handle kit for T760.00S ③	T760.00R	T760.00R
	Trolley ④ (②+③)	T760.00SR	T760.00SR